

SIDE VIEW

FRONT VIEW

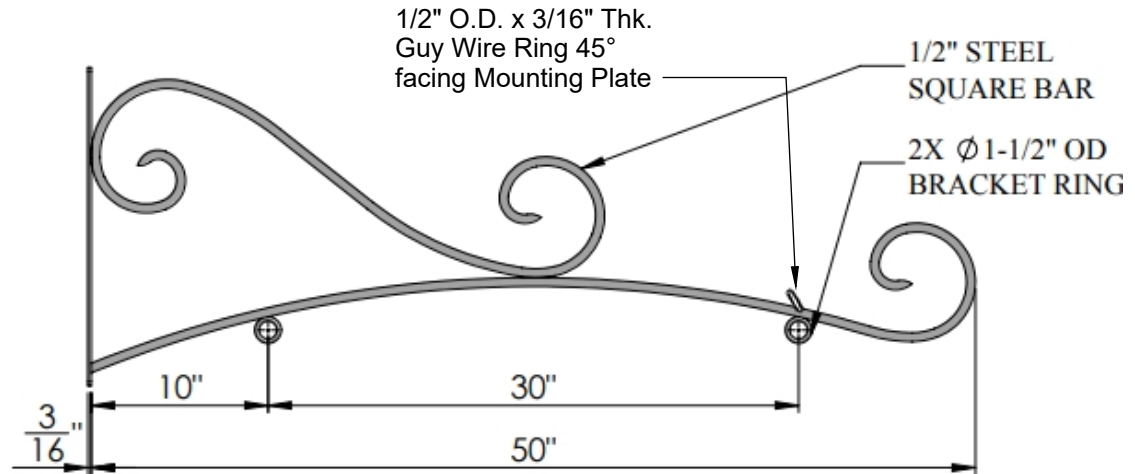
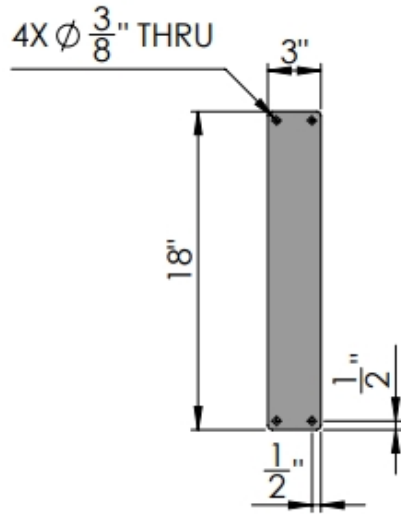
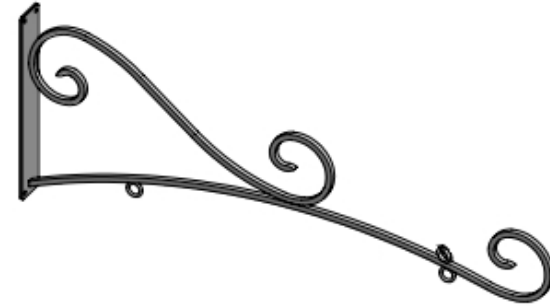

GENERAL NOTES

SIGN BRACKET
—STORE—

A CARLSBAD MANUFACTURING COMPANY

1 (888) 919-7446

SignBracketStore.com

PRODUCT DESCRIPTION				SKU				PREPARED FOR		APPROVAL SIGNATURE
MILANO ARCH HANGING BLADE SIGN BRACKET				371B-50LP						
DIMENSIONS	MATERIAL	COLOR / FINISH	REP	DB	DATE	REV	ORDER #	PROJECT / SIDEMARK / IF#		APPROVAL DATE
50"L	STEEL	Textured Black Powder Coat	Gordana	RM	01/2025					

PLEASE NOTE: Due to the handmade nature of our products, individual measurements may vary from those listed. The provided dimensions are for reference only

All images are the intellectual property of Sign Bracket Store. Reproduction in any form is strictly prohibitive without the express written permission of Sign Bracket Store. All designs are property of Sign Bracket Store.