

Hardware Included (PER ARM):

- (2) 5/16"-18 x 6"L Zinc Coated Carriage Bolt
- (6) 5/16"-18 Zinc Coated Hex Nut
- (6) 5/16" Lock Washer
- (6) 5/16" Flat Washer

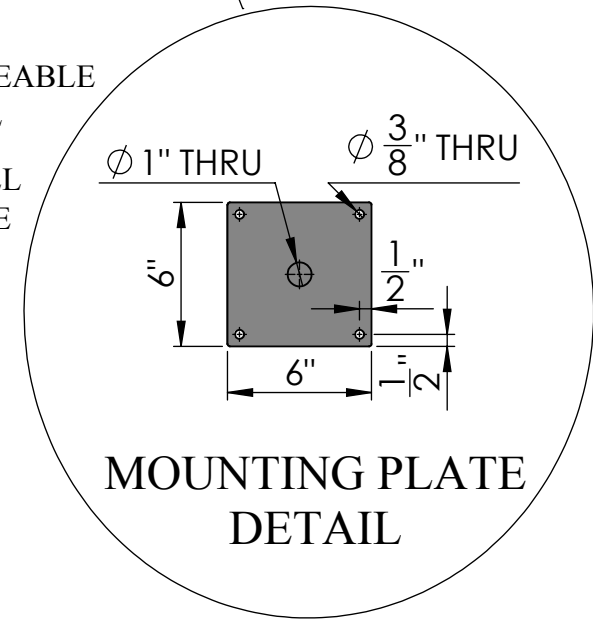
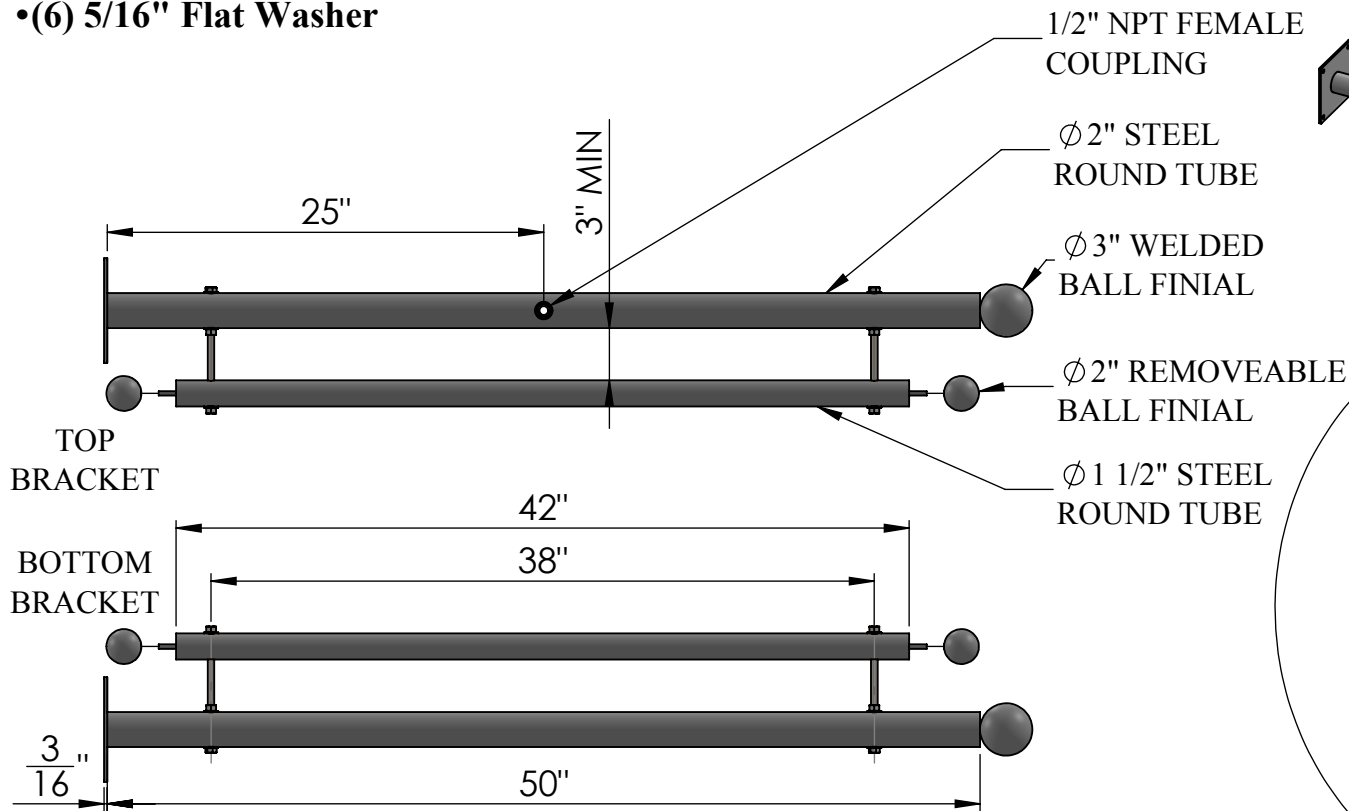
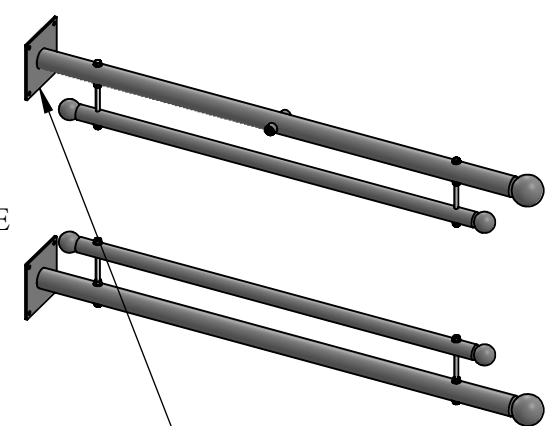

FRONT VIEW

Date: 09/2015
 Scale: NTS
 DB: CF
 CB:
 Order#:

Content: Lighted Trapeze Banner Bracket for 36" Banner
 PN: 303B-WM-WL-36
 Color/Finish: Textured Black Powder Coat
 Customer Approval: _____

Design by Sign Bracket Store. All visual representations and designs are the intellectual property of Sign Bracket Store and protected under copyright law. Any duplication of this design is in direct violation of the law and will result in legal action.
 © Copyright 2008-2015



T: 888-919-7446

F: 760-603-0812